

**INFINITE QUALITY**



**ATLASSIAN**  
**CATALOG**

**PARTS & ACCESSORIES**



**ATLASSIAN**

**BEST QUALITY**

**BEST PRICE**



**ENJOY THE SAFE  
& SMOOTH RIDE**

**WWW.ATSATLASSIAN.COM**





# LINER, PISTON, RING FOR MF/PERKINS ENGINES DESIGNED BY ATLASSIAN ENGINEERS





# LINER, PISTON, RING FOR PEUGEOT ENGINES DESIGNED BY ATLASSIAN ENGINEERS







**PISTON ASSY (ALFIN - U5LP0009)**

پیستون آلفین دار ۳ رینگ

CODE : U5LP0009



**PISTON ASSY (ALFIN - U5LL0015)**

پیستون آلفین دار تراکتور ۳۹۹

CODE : ALFIN - U5LL0015



**PISTON ASSY (FHC89207)**

پیستون معمولی ۴ رینگ

CODE : FHC89207



**PISTON ASSY (FFU5LP0009)**

پیستون معمولی ۳ رینگ

CODE : FFU5LP0009



**PISTON ASSY (ALFIN-3135J186)**

پیستون آلفین دار بادسان

CODE : ALFIN-3135J186



**PISTON ASSY (ALFIN - 89207)**

پیستون آلفین دار ۴ رینگ

CODE : ALFIN 89207







**PISTON ASSY (86740)**

پیستون نافی دار پرکینز قدیم

CODE : 86740



**PISTON ASSY (ALFIN-68301)**

پیستون آلفین دار ۵ رینگ

CODE : ALFIN-68301



**PISTON ASSY ( 68301 )**

پیستون معمولی ۵ رینگ

CODE : 68301



**PISTON ASSY ( UTB 650 )**

پیستون تراکتور رومانی

CODE : UTB650 - 108mm



**PISTON ASSY ( 470 )**

پیستون تراکتور ۴۷۰

CODE : MF 470



**PISTON ASSY (Peugeot 405)**

پیستون پژو ۴۰۵

CODE : Peugeot 405







**PISTON ASSY (Peugeot 206)**

پیستون پژو ۲۰۶ - تیپ ۲

CODE : Peugeot 206



**PISTON ASSY (68332)**

پیستون معمولی ۵ رینگ ۲۴۰

CODE : 68332



**PISTON ASSY (ALFIN - 68332)**

پیستون آلفین دار ۵ رینگ ۲۴۰

CODE : ALFIN - 68332



**PISTON ASSY (81512)**

پیستون سر تخت ۵ رینگ

CODE : 81512



**Cylinder Liner Semi Finished (3135X031)**

بوش موتور نخورده آذرخش

CODE : 3135X031



**Cylinder Liner Fully Finished (3135X032)**

بوش موتور خورده آذرخش

CODE : 3135X032





Cylinder Liner Semi Finished (3135X041)

بوش موتور نخورده ۳۹۹

CODE : 3135X041



Cylinder Liner Semi Finished  
(3135X041 O/S 0.05mm)

بوش موتور اورسایز پنج صدم نخورده ۳۹۹

CODE : 3135X041 O/S 0.05mm



Cylinder Liner Semi Finished  
(3135X041 O/S 0.5mm)

بوش موتور اور سایز نیم نخورده ۳۹۹

CODE : 3135X041O/S 0.5mm



Cylinder Liner Semi Finished  
(3135X041 O/S 0.75mm)

بوش موتور اور سایز هفتادو پنج صدم نخورده ۳۹۹

CODE : 3135X041 O/S 0.75mm



Cylinder Liner Fully Finished (3135X042)

بوش موتور خورده ۳۹۹

CODE : 3135X042



Cylinder Liner Fully Finished  
(3135X042 O/S 0.05mm)

بوش موتور اورسایز پنج صدم خورده ۳۹۹

CODE : 3135X042 O/S 0.05mm







Cylinder Liner Fully Finished (3135X062)

بوش موتور خورده بادسان و فوتون

CODE : 3135X062



Cylinder Liner Fully Finished  
(3135X062 O/S 0.05mm)

بوش موتور اورسایز پنج صدم خورده بادسان و فوتون

CODE : 3135X062 O/S 0.05mm



Cylinder Liner Semi Finished (3135X063)

بوش موتور نخورده بادسان و فوتون

CODE : 3135X063



Cylinder Liner Semi Finished (31358323)

بوش موتور نخورده ۳ سیلندری ۲۴۰

CODE : 31358323



Cylinder Liner Semi Finished  
(31358346 O/S 0.05mm)

بوش موتور اورسایز پنج صدم نخورده ۲۸۵

CODE : 31358346 O/S 0.05mm



Cylinder Liner Semi Finished  
(31358346 O/S 0.5mm)

بوش موتور اورسایز نیم نخورده ۲۸۵

CODE : 31358346 O/S 0.5mm





Cylinder Liner Semi Finished  
(31358346 O/S 0.75mm)

بوش موتور اورسایز هفتاد و پنج صدم نخورده ۲۸۵

CODE : 31358346 O/S 0.75mm



Cylinder Liner Semi Finished  
(O/S 1.0mm 31358346)

بوش موتور اورسایز یک میلی متری نخورده ۲۸۵

CODE : 31358346 O/S 1.0mm



Cylinder Liner Fully Finished  
(O/S 0.05mm 31358352)

بوش موتور اورسایز پنج صدم خورده ۲۸۵

CODE : 31358352 O/S 0.05mm



Cylinder Liner Fully Finished (31358352)

بوش موتور خورده ۲۸۵

CODE : 31358352



Cylinder Liner Semi Finished (31358393)

بوش موتور پرکینز سری ۹۰۰ نخورده ۳۹۳

CODE : 31358393



Cylinder Liner Fully Finished (31358394)

بوش موتور پرکینز سری ۹۰۰ خورده ۳۹۴

CODE : 31358394







**Cylinder Liner Semi Finished (31358346)**

بوش موتور نخورده ۲۸۵

CODE : 31358346



**Cylinder Liner Fully Finished (Peugeot 405)**

بوش موتور پژو ۴۰۵

CODE : Peugeot 405



**Cylinder Liner Fully Finished (Peugeot 206)**

بوش موتور پژو ۲۰۶ - تیپ ۲

CODE : Peugeot 206



**Cylinder Liner (UTB650-108mm)**

بوش موتور رومانی ۱۰۸ میلی متری

CODE : UTB650-108mm



**RING SET (4181A019-4Cylinder)**

رینگ موتور ۴۷۵ کنسروی فلزی

CODE : 4181A019-4Cylinder



**RING SET (4181A019-6Cylinder)**

رینگ موتور ۳۹۹ کنسروی فلزی

CODE : 4181A019-6Cylinder





### RING SET (4181A026)

رینگ موتور بادسان و ۱۵۰۰ کانسروی فلزی

CODE : 4181A026



### RING SET (41158022)

رینگ موتور سه رینگ کانسروی فلزی

CODE : 41158022



### RING SET (41158041)

رینگ موتور ۵ رینگ کانسروی فلزی

CODE : 41158041



### RING SET (41158065)

رینگ موتور ۲۴۰ چهار رینگ کانسروی

CODE : 41158065



### RING SET (UTB650 110-03-025)

رینگ موتور رومانی کانسروی فلزی

CODE : UTB650 110-03-025



### RING SET (4181A009)

رینگ موتور چهار رینگ کانسروی فلزی

CODE : 4181A009







**RING SET (Peugeot 405)**

رینگ موتور فلزی پژو ۴۰۵ اطلسیان

CODE : Peugeot 405



**RING SET (Peugeot 206)**

رینگ موتور فلزی پژو ۲۰۶ اطلسیان

CODE : Peugeot 206



**Connecting Rod Budsun (ZZ90146)**

شاتون بادسان

CODE : ZZ90146



**Connecting Rod MF 240 (ZZ90010)**

شاتون تراکتور ۲۴۰

CODE : ZZ90010



**Connecting Rod MF 285 (ZZ90009)**

شاتون تراکتور ۲۸۵

CODE : ZZ90009



**Connecting Rod (UTB650)**

شاتون تراکتور رومانی

CODE : UTB650





**Connecting Rod MF Fiat 445 (Fiat 32MM)**

شاتون تراكتور فيات ٤٤٥

CODE : Fiat 32MM



**Connecting Rod MF 475 (2.3 kgr)**

شاتون تراكتور ٤٧٥

CODE : MF475 (2.3KGR)



**Bearing Set MF 285 (STD-A-B-C)**

ياتاقان تراكتور ٢٨٥ ثابت و متحرك

CODE : STD - A - B - C



**Bearing Set MF 399 (STD-A-B-C)**

ياتاقان تراكتور ٣٩٩ ثابت و متحرك

CODE : STD - A - B - C



**Bearing Set UTB650 (STD-A-B-C)**

ياتاقان تراكتور روماني ثابت و متحرك

CODE : STD - A - B - C



**Cylinder head (UTB650)**

سر سيلندر تراكتور روماني (كامل)

CODE : UTB650 - 108mm







### Cylinder head MF 285

سرسیلندر تراکتور ۲۸۵ (کامل و لخت)

CODE : MF285



### Cylinder block MF 285

بلوک سیلندر تراکتور ۲۸۵

CODE : 4.248



### Cylinder block MF 399

بلوک سیلندر تراکتور ۳۹۹ و لوول ۶

CODE : MF399



### CrankShaft Budsun

میل لنگ بادسان

CODE : Budsun



### CrankShaft MF 285 42CrMo4

میل لنگ تراکتور ۲۸۵ کروم ۴۲

CODE : MF285 (42CrMo4)



### CrankShaft MF 240

میل لنگ تراکتور ۲۴۰ (انواع مدل)

CODE : MF 240





### CrankShaft UTB 650

میل لنگ تراکتور رومانی

CODE : UTB650



### CrankShaft MF 399 - 42 Cro

میل لنگ تراکتور ۳۹۹

CODE : MF 399



### T.WASHER MF 285 - STD - A

بغل یاتاقان استاندارد و تعمیر اول ۲۸۵

CODE : MF285 - STD - A



### ENGINE VALVE UTB 650

سوپاپ تراکتور رومانی استاندارد

CODE : STD



### ENGINE VALVE MF 240

سوپاپ تراکتور ۲۴۰ استاندارد

CODE : STD



### ENGINE VALVE MF 285

سوپاپ تراکتور ۲۸۵ استاندارد لبه نازک و لبه کلفت  
اول و دوم

CODE : A - B - STD







**Set of Liners, Pistons, 5Rings 4cylinder Perkins**

ست بوش، پیستون، رینگ، ۵ رینگ، خورده و نخورده  
با پیستون معمولی و آلفین دار

CODE : 5Rings 4cylinder,Perkins



**Set of Liners, Pistons, 3Rings 4cylinder MF285**

ست بوش، پیستون، رینگ، ۳ رینگ خورده و نخورده  
با پیستون کمر بند دار و آلفین دار

CODE : 3Rings 4cylinder,MF285



**Set of Liners, Pistons, 4Rings 4cylinder MF285**

ست بوش، پیستون، رینگ، ۴ رینگ خورده و نخورده  
با پیستون کمر بند دار و آلفین دار

CODE : 4Rings 4cylinder,MF285



**Set of Liners, Pistons, Rings 4cylinder Budsun**

ست بوش، پیستون، رینگ، چهار سیلندر بادسان  
خورده و نخورده با پیستون آلفین دار

CODE : 4cylinder,Budsun



**Set of Liners, Pistons, Rings 4cylinder MF 475**

ست بوش، پیستون، رینگ، چهار سیلندر تراکتور ۴۷۵  
خورده و نخورده با پیستون آلفین دار

CODE : 4cylinder,MF475



**Set of Liners, Pistons, Rings 6cylinder MF 399**

ست بوش، پیستون، رینگ، ۶ سیلندر تراکتور ۳۹۹  
خورده و نخورده با پیستون آلفین دار

CODE : 6cylinder,MF399







Set of Liners, Pistons, Rings UTB 650 - 108mm

ست بوش، پیستون، رینگ، رومانی

CODE : UTB650-108mm



HYD, LIFT ARM MF 285 - 399

بوش بازو تراکتور ۲۸۵ و ۳۹۹

CODE : 1870934



CAM BUSH UTB 650

بوش میل سوپاپ تراکتور رومانی

CODE : 194-195-196



C.R BUSH N.H32mm

بوش شاتون فیات

CODE : 4555699



FRONT SUPPORT BUSH MF 285

بوش هزار خار خورده و نخورده ۲۸۵

CODE : 897235



C.R BUSH MF 285

بوش پدال کلاچ ۲۸۵

CODE : 284592







**C.R BUSH MF285 & MF399**  
بوش شاتون ۲۸۵ و ۳۹۹  
CODE : 31134123



**C.R BUSH MF 399**  
بوش سگدست ۳۹۹  
CODE : 882327



**C.R BUSH MF 265**  
بوش اکسل تراکتور ۲۸۵  
CODE : 897712



**C.R BUSH Budsun & Foton**  
بوش شاتون بادسان و فوتون  
CODE : 3112E005



**C.R BUSH Budsun OS4**  
بوش شاتون بادسان اورسایز  
CODE : 3112E005OS4



**BUSH MF 285**  
بوش سگدست تراکتور ۲۸۵  
CODE : 183086





### C.R BUSH UTB 650

بوش شاتون رومانی

CODE : 118031109



### C.P BUSH MF 399

بوش اکسل تراکتور ۳۹۹

CODE : 1675908



### C.P BUSH MF 285

بوش مچی رو تراکتور ۲۸۵

CODE : 190560



### C.P BUSH MF 285

بوش میل سوپاپ ۲۸۵

CODE : 31134165



### Steering Pump Tractor MF285

پمپ فرمان تراکتور ۲۸۵

CODE : H20A6.3X319



### steering Pump Tractor MF399

پمپ فرمان تراکتور ۳۹۹

CODE : H22A11/8.2X629







**Steering Pump Tractor MF475 & 299**

پمپ فرمان تراکتور ۴۷۵ و ۲۹۹

CODE : 10769T91



**Carbon Brush Starter**

زغال استارت

CODE : 1011



**Start Motor tractor MF 285&399**

استارت کامل تراکتور ۲۸۵ و ۳۹۹

CODE : LRS232



**Carbon Brush Holder Starter**

جا زغالی استارت

CODE : 1051



**Carbon Bush Starter**

بوش استارت چهار تیکه

CODE : 1021



**Solenoid Switch**

اتوماتیک استارت چهار پیچ

CODE : 110





### Solenoid Switch Starter

توماتیک استارت دو پیچ گرد

CODE : 109



### Solenoid Switch Starter

اتوماتیک استارت دو پیچ تی

CODE : 159



### Gear Starter

دنده استارت شیب کند و شیب تند

CODE : 285 - 034



### Field Coil

بالشتک استارت تک سیم

CODE : 462



### Field Coil

بالشتک استارت دو سیم

CODE : 428



### Armature Starter

آرمیچر استارت شیب کند و شیب تند

CODE : 590 - 382







### Flywheel MF 285

فلايويل ۲۸۵

CODE : 41117084



### Flywheel MF 399

فلايويل ۳۹۹

CODE : 4111D123



### UTB650 HYDRAULIC STEERING PUMP

پمپ هيدروليک رومانی

CODE : UTB HB-102



### Tractor Seat MF285-MF399

صندلی آبی تراکتور ۲۸۵ و ۳۹۹

CODE : MF285 - MF399



### Steering unit MF 285 & 399

اوربیترویل ۲۸۵ و ۳۹۹

CODE : 101S-100 G1/2



### CONTROL VALVE

شیر کنترل ۸۰ لیتری ۴ جک

CODE : 02P80





### Clutch Assy MF 285

مجموعه کامل دیسک کلاچ تراکتور ۲۸۵

CODE : 1868008M91



### Clutch Assy MF 399

مجموعه کامل دیسک کلاچ تراکتور ۳۹۹

CODE : 3701015M91



### Spring Clutch Release

فنر دیسک کلاچ

CODE : 886396M1



### Clutch Assy Repair Kit MF 285

کیت تعمیر دیسک کلاچ تراکتور ۲۸۵

CODE : MF285



### Brake Plate Copper MF 285

صفحه ترمز برنزی تراکتور ۲۸۵

CODE : 1860964M2



### Brake Plate Steel MF 285

صفحه ترمز آهنی تراکتور ۲۸۵

CODE : 02P80







PTO Clutch Plate Steel & Copper MF 399

صفحه آهنی و برنزی کلاچ بک ۳۹۹

CODE : 1688532M1 / 1870860M1



Alternator

دینام ۲ پایه قدیم

CODE : Alternator



Alternator MF 285 (65A)

دینام جدید سه پایه تراکتور ۲۸۵ (۶۵A)

CODE : AlternatorMF285/65A



Alternator 2Pulley MF 399 (75A)

دینام ۳ پایه دوپولی تراکتور ۳۹۹ (۷۵A)

CODE : Alternator 2Pulley MF399/75A



Alternator Peugeot 405

دینام پژو ۴۰۵

CODE : Alternator Peugeot 405



Alternator Peugeot 206

دینام پژو ۲۰۶

CODE : Alternator Peugeot 206







### Alternator Kia Pride

دینام پراید

CODE : Alternator Kia Pride



### PTO Plate MF 285

صفحه خرمکوب ۲۸۵

CODE : 1865836M91



### Clutch Plate GOLD MF 285

صفحه کلاچ تراکتور ۲۸۵ طلایی

CODE : 887889M94-GOLD



### Clutch Plate SILVER MF 285

صفحه کلاچ تراکتور ۲۸۵ نقره ای معمولی

CODE : 887889M94-SILVER



### Clutch Plate UTB 650

صفحه کلاچ تراکتور رومانی

CODE : 36-10-010/36.16.010



### Clutch Plate MF 399

صفحه کلاچ ۶ پر تراکتور ۳۹۹

CODE : CLP 13-6







**Clutch Plate Sintered, Bronz MF 285**

صفحه کلاچ تمام سرامیکی تراکتور ۲۸۵

CODE : 887890



**Clutch Kit Peugeot 405**

کیت کامل دیسک کلاچ پژو ۴۰۵

CODE : Peugeot 405



**Clutch Kit Peugeot 206**

کیت کامل دیسک کلاچ پژو ۲۰۶

CODE : Peugeot 206



**Clutch Kit IKCO Runna**

کیت کامل دیسک کلاچ رانا

CODE : IKCO-RUNNA



**Clutch Kit Kia Pride**

کیت کامل دیسک کلاچ پراید

CODE : Kia Pride



**Clutch Kit Saipa Tiba 200**

کیت کامل دیسک کلاچ تیبیا ۲۰۰

CODE : Saipa Tiba 200







### Clutch Kit Saipa Tiba 215

کیت کامل دیسک کلاچ تیبیا ۲۱۵

CODE : Saipa Tiba 215



### Clutch Kit Paykan

کیت کامل دیسک کلاچ پیکان

CODE : Paykan



### Oil pump Perkins

اوایل پمپ پرکینز زمینی

CODE : 41314182



### Oil Pump MF 399

اوایل پمپ تراکتور ۳۹۹

CODE : 4132F057



### Oil Pump UTB650 (thick shaft 15MM)

اوایل پمپ رومانی شفت نازک ۱۵ میلی متری

CODE : 110.08.012



### Oil Pump UTB650 (thick shaft 18MM)

اوایل پمپ رومانی شفت کلفت ۱۸ میلی متری

CODE : 110.08.012







### Water pump MF 399

واتر پمپ تراکتور ۳۹۹

CODE : U5MW0159



### Water pump MF 285

واتر پمپ تراکتور ۲۸۵ با پولی

CODE : 41313201



### Balancer Unit tractor MF285

بالانسر (اوایل پمپ لنگری) تراکتور ۲۸۵

CODE : 41733082



### Oil Seal

کاسه نمد کوچک قیفی کلاچ

CODE : 1860011



### Oil Seal

کاسه نمد بزرگ قیفی کلاچ

CODE : 1860867M3



### Oil Seal Timing

کاسه نمد سر میل لنگ ۲۸۵

CODE : 2218F436





### Oil Seal Main

کاسه نمد ته میل لنگ تراکتور ۲۸۵

CODE : 2418F475



### Oil Seal Main & Timing Fiat

کاسه نمد سر و ته تراکتور فیات

CODE : 40000720+98461684



### Oil Seal Main

کاسه نمد فلزی

CODE : 2418F701

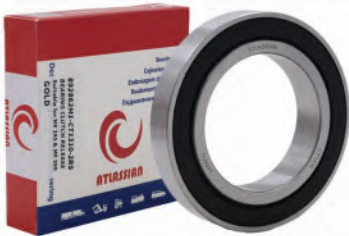

### Bearing Clutch Release GOLD MF 285 & 399

بلبرینگ کلاچ طلایی ۲۸۵ و ۳۹۹

CODE : CT13110

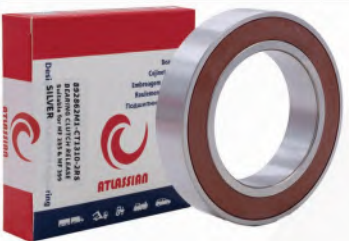

### Bearing Clutch Release SILVER MF 285 & 399

بلبرینگ کلاچ نقره ای ۲۸۵ و ۳۹۹

CODE : CT1310 2RS



### BALL JOINT 045 MF 399

سیبک گرد ۳۹۹ تک دیفرانسیل

CODE : 1695045M91







### RACK ENDS MF 399 - 4WD

سیبک دوسر رزوه جفت دانا

CODE : RE-1711AR



### TIE ROD ASSEMBLY MF 285

سیبک کامل ۲۸۵

CODE : 886796M92



### TIE ROD ENDS MF 399 - 4WD

سیبک بلند جفت ۳۹۹

CODE : TR-1719A



### ROD END MF 399

سیبک زانویی ۳۹۹ تک دیفرانسیل

CODE : TR-2359



### TIE ROD ENDS MF 285 - 4WD

سیبک بلند جفت چهار سیلندری

CODE : TR-5657



### DRAG LINK ASSEMBLY UTB 650

سیبک بلند رومانی

CODE : DL-21A





### TIE ROD ENDS UTB 650

سیبک کوتاه رومانی

CODE : TR-21A



### Valve Guid -1SET-IN & EX MF 285

گاید سوپاپ کامل ۲۸۵

CODE : 3343F002-J002



### Valve Guid -1SET-IN & EX UTB 650

گاید سوپاپ کامل رومانی

CODE : 103.02.107



### Stop Solenoid LARGE

قطع کن پمپ گازوئیل سوکت درشت

CODE : 189646



### Stop Solenoid TINY

قطع کن پمپ گازوئیل سوکت ریز

CODE : 189646



### Full Gasket Set FIAT

واشر کامل با سرسیلندر تراکتور فیات

CODE : 1900186







ATLASSIAN



### Full Gasket Set MF 285

واشر کامل با سر سیلندر تراکتور ۲۸۵

CODE : U5LT0015+U5LB0016



### Full Gasket Without Cylinder Head MF 285

واشر کامل بدون سر سیلندر تراکتور ۲۸۵

CODE : U5LT0015+U5LB0016



### Full Gasket Set MF 399

واشر کامل با سر سیلندر تراکتور ۳۹۹

CODE : U5LT1179+U5LB0153



### Full Gasket Without Cylinder Head MF 399

واشر کامل بدون سر سیلندر تراکتور ۳۹۹

CODE : U5LT1179+U5LB0153



### Cylinder Head Gasket MF 285

واشر سرسیلندر تراکتور ۲۸۵

CODE : 36812349



### Cylinder Head Gasket MF 399

واشر سرسیلندر تراکتور ۳۹۹

CODE : 3681H208







**Cylinder Head Gasket PERKINS  
900Series**

واشر سرسیلندر موتور پرکینز ۶ سیلندر قدیم

CODE : 3681H202



**Full Gasket Set 240 - 135**

واشر کامل تراکتور ۱۳۵-۲۴۰ با سرسیلندر

CODE : 82886+82887



**Cylinder Head Gasket 240 - 135**

واشر سرسیلندر مسی تراکتور ۲۴۰-۱۳۵

CODE : 36812127



**Cylinder Head Gasket BUDSUN**

واشر سرسیلندر بادسان

CODE : 3681E037



**Cylinder Head Gasket  
PERKINS 1006 TURBO**

واشر سرسیلندر موتور پرکینز ۱۰۰۶ توربو

CODE : 3681H208



**Cylinder Head Gasket  
PERKINS 1004 TURBO**

واشر سرسیلندر موتور پرکینز ۱۰۰۴ توربو

CODE : 36812349







ATLASSIAN



### Cylinder Head Gasket FIAT

واشر سرسیلندر تراکتور فیات

CODE : 4601057



### COUNTER SHAFT MF 399

شفت زیر گیربکس ۳۹۹

CODE : 1677827M3



### GEAR36T / 44DT MF 399

۳۶ دنده ۳۹۹ دوقلو پشت کشویی شفت رو

CODE : 1686028M91



### GEAR 468 44T MF 399

۴۴ دنده ۳۹۹ پشت کشویی شفت رو

CODE : 1686468M91



### GEAR 127 MF 399

دنده عقب تراکتور ۳۹۹

CODE : 1688127M1



### GEAR 429 40T MF 399

۴۰ دنده ۳۹۹ پشت کشویی شفت رو

CODE : 1687429M91





Upper shaft MF 285

شفت رو گیربکس ۲۸۵

CODE : 1687642M1



Counter shaft MF 285

شفت زیر گیربکس ۲۸۵

CODE : 906472M1



Gear 688 MF 285

دنده یک روی ۲۸۵

CODE : 1682688M1



Shaft Pto Drive 16T MF 285

شفت قیفی کلاچ ۲۸۵

CODE : 1868531M91



Shaft 24T MF 285

شفت حرکت (۲۴ دنده) ۲۸۵

CODE : 964925M3



Gear Pinion Epicyclic MF 285

دنده توپی کوچک ۲۸۵

CODE : 894769M1







ATLASSIAN



### GEAR 21T MF 285

دنده توپی چرخ عقب بزرگ ۲۸۵

CODE : 897005M1



### PINION PLATANRY MF 399

دنده توپی چرخ عقب بزرگ ۳۹۹

CODE : 1692736M1



### CROWN WHEEL & PINION MF 399

کرانویل پینیون ۳۹۹

CODE : 3900698M91



### IDLER HEAR 63T MF 399 & 285

دنده هرزگرد ۲۸۵ و ۳۹۹

CODE : 41115023



### RING GEAR(SQUARE TYPE) MF 285

کلاف کمک ۲۸۵

CODE : 1867424M2



### GEAR 42T/44DT MF 285

دنده یک ۴۲ دنده ۳۹۹

CODE : 1686467M1





**DIFF.GEAR 518 MF 285**

دنده دیشلی بزرگ ۲۸۵

CODE : 885518M1



**DIFF.PINION 725 MF 285**

دنده دیشلی کوچک ۲۸۵

CODE : 897725M1



**SPIDER CROSS 302 MF 285**

چهار شاخه دیفرانسیل ۲۸۵

CODE : 894302M2



**REAR WHEEL HUB COIL MF 285**

کلاف توپی چرخ عقب ۲۸۵

CODE : 894772M1



**SHAFT INPUT 20T MF 399**

شفت قیفی کلاچ ۳۹۹

CODE : 3599579M1



**CAM SHAFT GEAR MF 285**

دنده میل سوپاپ ۲۸۵

CODE : 31171353







ATLASSIAN



**GEAR 690 MF 285**

دنده سه رو ۲۸۵

CODE : 1682690M1



**COUPLING SHEAR MF 285**

واسطه کرانویل پینیون ۲۸۵

CODE : 1680189M91



**MAIN SHAFT 449 MF 240**

شفت رو ۲۴۰

CODE : 1682449



**PINION HIGH SPEED 33T**

دنده ۴ زیر ۴۱۵

CODE : 180415M1



**PINION INTERM SPEED 23T**

دنده ۲ زیر ۴۱۹

CODE : 180419M1



**SHAFT REVERS GEAR MF 285**

شفت دنده عقب ۲۸۵

CODE : 180445M1





**CLUSTER REVERSE GEAR MF 285**

دنده عقب ۲۸۵

CODE : 183040M1



**GEAR PTO 532 MF 285**

دنده تخت بزرگ خرمنکوب ۲۸۵

CODE : 1868532M1



**DRIVE SHAFT En-9 SHAFT MF 285**

شافت کوتاه اوایل پمپ ۲۸۵

CODE : 743115



**DRIVE SHAFT LONG MF 285**

شافت بلند اوایل پمپ ۲۸۵

CODE : 743137M1



**CONNECTING ROD 410 MF 285**

شاتون مینی بلوک ۲۸۵ قدیم

CODE : 886410M1



**SHAFT PINION GEAR MF 285**

شفت دنده (پین) توپی ۲۸۵

CODE : 1864869







ATLASSIAN



**GEAR CONSTANT MESH 469 MF 285**

دنده شفت تو خالی ۲۸۵ زیر

CODE : 906469M1



**GEAR 916 MF 285**

دنده سه زیر ۲۸۵

CODE : 964916M1



**CRANK GEAR 30T MF 285**

دنده سر وزنه اوایل پمپ ۲۸۵

CODE : 31164582



**SYNCHRO MESH GEAR MF 399**

دنده شفت زیر (۳۳دنده) ۳۹۹

CODE : 1617923M3



**CROWN WHEEL & PINION MF 285**

کرانویل پینیون ۲۸۵

CODE : 1664255M92



**THRESHING GEAR MF 285**

دنده گلودار خرمکوب ۲۸۵

CODE : 532907M1





**HIGH/LOW SPEED GEAR 28T**

کشویی کمک ۲۸۵

CODE : 1866557M1



**SHAFT MAIN DRIVE MF 399**

شفت حرکت ۳۹۹

CODE : 1692502



**DOUBLE GEAR 691 MF 285**

دنده دوقلو ۲۸۵

CODE : 1682691M1



**STAR KIT**

دنده دیشلی کامل دیفرانسیل

CODE : STARKIT



**AXLE SHAFT MF 285**

پلوس بشقابی ۲۸۵

CODE : 884850M2



**GEAR PLATNARY 737 MF 399**

دنده توپی چرخ عقب کوچک ۳۹۹

CODE : 1692737M1







ATLASSIAN



### PLANET GEAR 23T MF 285 & 399

دنده کاربرد کمک ۲۸۵ و ۳۹۹

CODE : 1866552M1



### PTO SHAFT BIG BUSH MF 285

شفت خرمکوب ۲۸۵

CODE : 1660288M91



### GEAR 25T/6SPL MF 399

دنده شفت حرکت ۳۹۹

CODE : 1692496M1



### INTERMEDIATE 430

دنده گیربکس ۳۹۹ - ۴۳۰

CODE : 1687430M1



### 3RD GEAR WITH BUSH MF 399

دنده گیربکس ۳۹۹ - ۵۰۱

CODE : 1692501M91



### GEAR PTO MF 399

دنده شفت خرمکوب ۳۹۹

CODE : 3599580M1



39

WWW.ATSATLASSIAN.COM



**2ND GEAR 34T/44DT MF 399**

دنده گیربکس ۵۰۰ - ۳۹۹

CODE : 1692500M91



**DRIVE SHAFT GEAR 497 MF 399**

دنده شفت حرکت ۴۹۷ - ۳۹۹

CODE : 1692497M1



**SUN GEAR 15T LONG MF 399**

دنده خورشیدی وسطی کاربرد چرخ جلو دانا ۳۹۹

CODE : 107165T1



**SUN GEAR 15T SHORT MF 285**

دنده خورشیدی وسطی کاربرد چرخ جلو دانا ۲۸۵

CODE : 107171T1



**GEAR 19T MF 285**

دنده سیاره ای دورکاربر چرخ جلو دانا ۲۸۵

CODE : 107823T1



**GEAR 232 MF 285**

دنده زد اف چرخ جلو ۲۸۵

CODE : 95353232







ATLASSIAN



**GEAR 455 MF 399**

دنده توپی چرخ جلو کارارو ۳۹۹

CODE : 125455



**SHAFT 18 T/22 SPL MF 285**

شفت زد اف پلوس کوتاه ۲۸۵

CODE : 44723531157

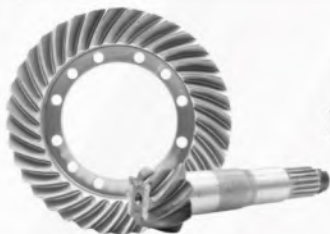

**CROWN WHEEL & PINION MF 285**

کرانویل پنیون دیفرانسیل جلو دانا ۲۸۵

CODE : 104767T1

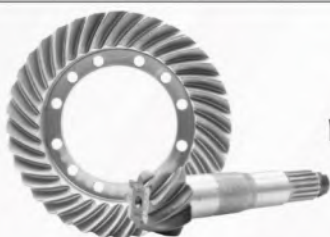

**CROWN WHEEL & PINION MF 399**

کرانویل پنیون دیفرانسیل جلو دانا ۳۹۹

CODE : 108984T1



**CRANK GEAR 105 MF 285**

دنده سر میل لنگ ۲۸۵

CODE : 3638105M1



**GEAR 061 MF 399**

دنده سر میل لنگ ۳۹۹

CODE : 3117C061





**RING GEAR 90T/51 SPL**

کلاف تویی چرخ جلو زد اف ۲۸۵

CODE : 4472353419



**GEAR 19T BIG MF 399**

دنده سیاره ای دور کریر چرخ جلو ۳۹۹

CODE : 107161T1



**SYN PLATE MF 399**

دنده بغل همزمان کننده ۳۹۹

CODE : 1686459M1



**GEAR P/STEERING PUMP MF 399**

دنده سر پمپ فرمان ۲۸۵

CODE : 897159M1



**GEAR-31/15T UTB 650**

دنده ۱۱۵ رومانی - ۵ رو

CODE : 31.17.115



**GEAR-41/26T UTB 650**

دنده ۱۱۴ رومانی یک و چهار

CODE : 31.17.114







ATLASSIAN



### GEAR 118 UTB 650

دنده ۱۱۸ رومانی دنده دو و عقب

CODE : 31.17.118



### GEAR-35 T/8 SPL UTB 650

دنده ۱۱۶ رومانی دنده دو

CODE : 31.17.116



### GEAR-41/30T UTB 650

دنده ۱۱۹ رومانی - ۵ زیر

CODE : 31.17.119



### CLUTCH SHAFT 184 UTB 650

شفت کوتاه دیسک کلاچ رومانی

CODE : 38.16.184



### CARRIER UNIT ASSY MF 285

کاریر کمک ۲۸۵

CODE : 1870538M91



### PTO SHAFT MF 399

شفت رابط بلند گیربکس ۳۹۹

CODE : 1869279M1



**SHAFT PTO FRONT MF 285**



شفت رابط گیربکس ۲۸۵

CODE : 1868533M1



**UPPER SHAFT MF 399**



شفت رو گیربکس ۳۹۹

CODE : 1662224M2





## MASSEY FERGUSON / PERKINS ENGINES

LINER TECHNICAL فنی بوش

ATLASSIAN REF.	Liner Type	A ( mm )	B ( mm )	C ( mm )	D ( mm )	E ( mm )	F ( mm )
<b>Semi-finished</b>							
31358323	I	91.49	93.71	216.03	96.62	3.81	
31358393	II	98.48	103.28	227.28	106.35	3.86	0.84
31358346	II	101.05	104.25	227.28	107.44	3.86	0.84
3135X031	I	98.48	104.25	226.44	107.37	3.81	
3135X033	I	101.05	104.20	225.54	107.37	3.81	
3135X041	I	100.00	104.28	226.44	107.44	3.86	
31358533	I	114.31	117.58	230.78	121.05	2.71	
3135X063	II	100.00	104.27	227.50	107.44	3.86	1.07
31358343	III	101.05	103.30	223.90			
14-020870	I	105.00	108.08	227.00	109.50	5.10	

<b>Fully Finished</b>							
31358345	I	91.49	93.66	216.03	96.47	3.78	
31358394	II	98.48	103.19	227.28	106.45	3.86	0.94
31358352	II	101.05	104.20	227.28	107.40	3.86	0.84
3135X032	I	98.48	104.20	226.44	107.37	3.81	
3135X034	I	101.05	104.20	225.43	107.37	3.81	
3135X042	I	100.00	104.23	226.44	107.44	3.86	
31358534	I	114.31	117.90	230.78	121.13	2.71	
3135X062	II	100.00	104.20	227.71	107.36	3.86	0.84

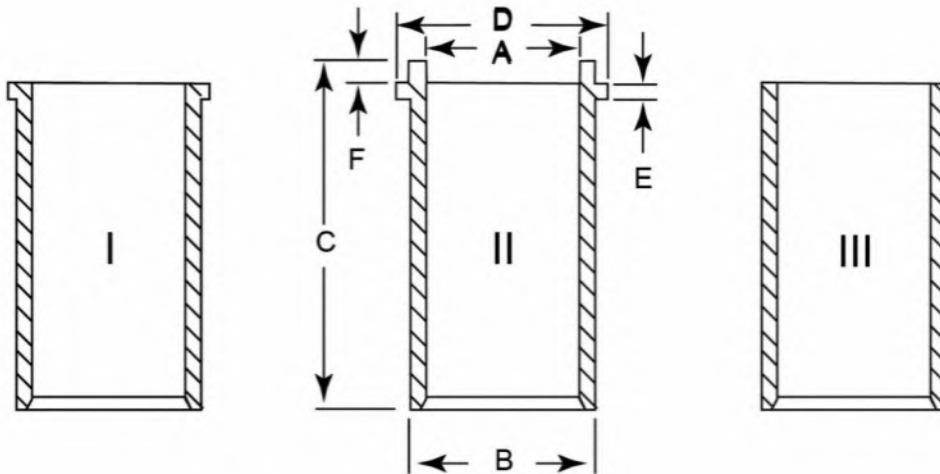

- A : Nominal Bore Diameter (mm)
- B : Outside Diameter (mm)
- C : Overall Length (mm)
- D : Flange Diameter (mm)
- E : Flange Height (mm)
- F : Recess Depth (mm)

**MASSEY FERGUSON / PERKINS ENGINES**

PISTON TECHNICAL فنی پیستون

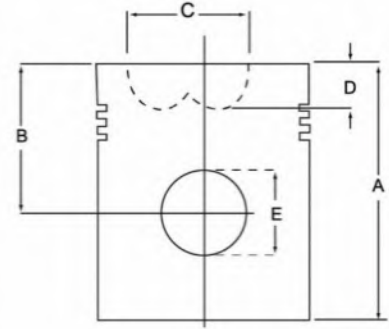
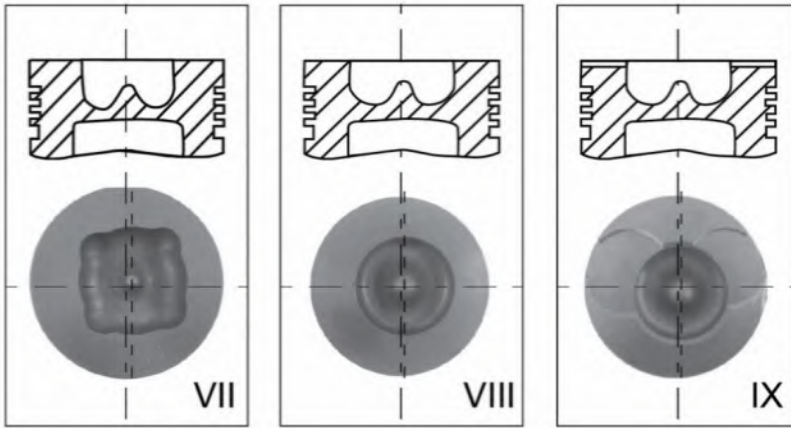
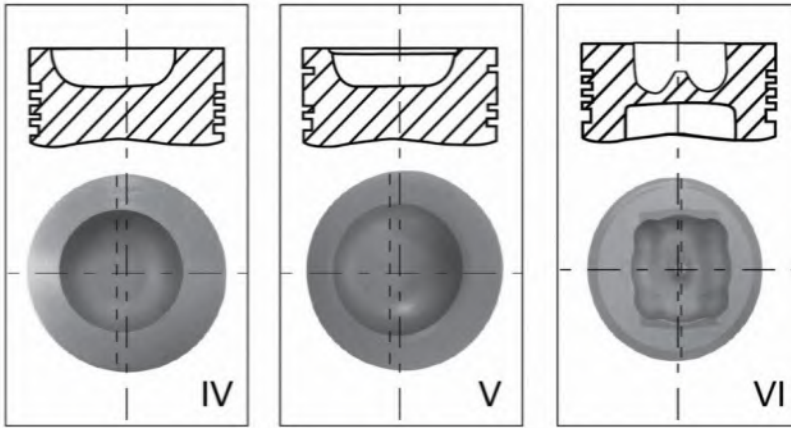
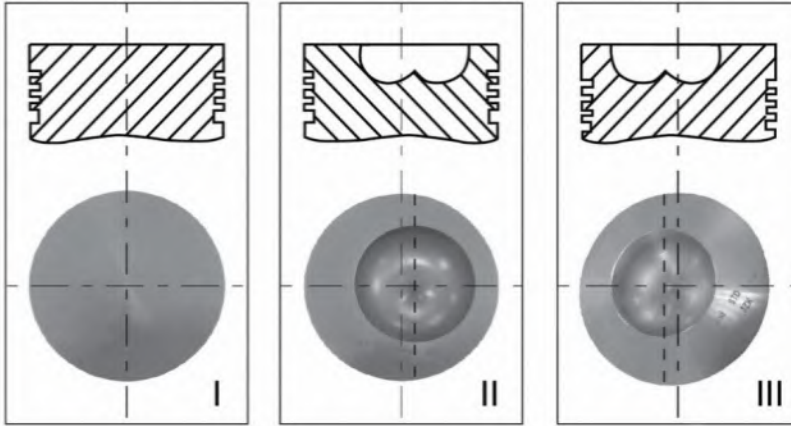

- A Overall length (mm)
- B Compression height(mm)
- C Combustion bowl diameter (mm)
- D Combustion bowl depth (mm)
- E Gudgeon pin diameter (mm)



**ATLASSIAN**

PISTON TECHNICAL فنی پیستون

ATLASSIAN REF.	CHAMBER TYPE	BORE DIA )mm(	NO. OF RINGS	ALFIN / NON ALFIN	A )mm(	B )mm(	C )mm(	D )mm(	E )mm(
89216	I	79.38	5	Non Alfin	79.9	45.6	-	-	23.812
81512	I	91.49	5	Non Alfin	107.70	56.90	----	----	31.75
68332	II	91.49	5	Non Alfin	109.34	61.72	55.90	18.30	31.75
68332	II	91.49	5	Alfin	109.34	61.72	55.90	18.30	31.75
89214	IV	91.49	4	Non Alfin	109.34	61.72	55.90	18.30	31.75
89214	IV	91.49	4	Alfin	109.34	61.72	59.70	19.00	31.75
U5LL0044	V	91.49	3	Alfin	108.92	61.76	59.75	18.30	31.76
86723	XI	91.49	3	Non Alfin	102.6	55.00	55.3	20.14	34.925
68301	IV	98.48	5	Non Alfin	121.00	70.20	61.00	20.35	34.93
68301 ALFIN	IV	98.48	5	Alfin	121.00	70.20	61.00	20.35	34.93
82878	IV	98.48	5	Non Alfin	120.65	69.90	61.00	20.40	34.93
82878 ALFIN	IV	98.48	5	Alfin	120.65	69.90	61.00	20.40	34.93
86740	II	98.48	5	Non Alfin	120.70	69.90	54.10	25.50	34.93
86721	IV	98.48	4	Non Alfin	127.4	76.6	59.7	19.1	34.925
68803	III	98.48	3	Alfin	107.9	69.9	66.7	18.9	38.1
U5LP0006	IV	98.48	3	Non Alfin	108.25	70.25	62.00	20.35	38.1
U5LP0022	V	98.48	3	Alfin	108.25	70.25	61.4	20.35	38.1
89206	IV	98.48	3	Non Alfin	116.3	76.6	54.00	20.00	34.925
86745	III	98.48	5	Non Alfin	120.7	70.35	61.00	20.20	34.925
86726	III	98.48	4	Non Alfin	120.4	69.75	67.20	19.20	38.10
U5LP0021	III	98.48	3	Alfin	121.00	70.20	54.10	25.70	34.93
U5LL0015 ALFIN	VII	100.00	3	Alfin	108.14	70.02	55.3 x 55.3	20.14	34.93
U5LL0014 ALFIN	VI	100.00	3	Alfin	108.14	70.02	55.8 x 66.2	17.00	38.10
3135J186	VIII	100.00	3	Alfin	108.23	70.16	52.80	15.75	39.70
U5LP0057	VIII	100.00	3	Alfin	108.00	70.23	52.8	21.7	39.7
89207	IV	101.05	4	Non Alfin	120.69	69.90	61.45	20.70	34.93
89207 ALFIN	IV	101.05	4	Alfin	120.69	69.90	61.45	20.70	34.93
U5LP0009	IV	101.05	3	Non Alfin	121.02	70.20	61.45	21.00	34.93
U5LP0009 ALFIN	IV	101.05	3	Alfin	121.02	70.20	61.45	21.00	34.93
U5LP0058	IX	103.00	3	Non Alfin	108.35	70.00	52.5	21.00	39.7
4115P011	X	105.00	3	Alfin	108	70.05	51.2	22.00	39.70
4115P015	VIII	105.00	3	Alfin	108.00	70.05	56.00	22.00	39.70
86716	II	114.30	4	Non Alfin	124.8	70.75	66.00	24.00	36.512

Gold Alfin Pistons are phosphate and graphite coated for rust prevention and solid lubrication respectively. For more details about Alfin Pistons please see the information box below.

**GOLD ALFIN PISTONS**

Gold 'alfin' pistons have a Ni-resist insert (with high nickel content) to reinforce the piston top groove which works at the highest temperature and pressure. This can double the life of the piston.







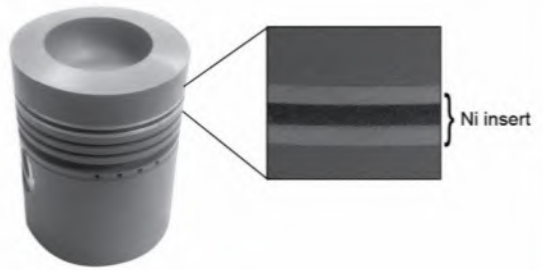













Normal Aluminum Piston

















































AlfinGold Piston





**MASSEY FERGUSON / PERKINS ENGINES**
**RING TECHNICAL** فنی رینگ



		DETAIL	
<b>41158085</b>	Dia: 79.38 mm		
1.99	R		
1.60	R IW		
1.60	R IW		
4.75	Du C		
4.75	S		
<b>41158058</b>	DIA:91.49 mm		
2.385	R P		
2.385	M P		
3.16	Lm		
6.335	S P		
6.335	S P		
<b>4181A017</b>	Dia: 91.49 mm		
3.0	T MoF P		
2.385	M C P		
3.5	DSF C		
<b>41158005</b>	Dia: 98.48 mm		
3.175	T MoF		
2.381	M P		
4.762	DSF C		
<b>41158031</b>	Dia: 98.48 mm		
3.16	R C		
2.38	R IF C		
2.38	R IF C		
6.33	DSF C		



		DETAIL	
<b>745823M91</b>	Dia: 88.92 mm		
2.38	R C		
2.38	R		
3.16	Lm		
6.33	Du C		
6.33	S		
<b>41158065</b>	Dia: 91.49 mm		
2.385	R CFP		
2.385	R IW P		
2.385	R IW P		
4.747	DSF C		
<b>68501</b>	DIA:91.49 mm		
2.385	R CFP		
2.385	R IW P		
3.16	NM P		
6.335	DSF C		
6.335	S P		
<b>41158026</b>	Dia: 98.48 mm		
2.385	R CFP		
2.385	R IW C		
2.385	R IW P		
6.335	S P		
6.335	S P		
<b>41158032</b>	Dia: 98.48 mm		
3.16	R C		
2.38	R IF C		
2.38	R IF C		
6.33	DSF C		
6.33	S		



		DETAIL	
<b>41158012</b>	Dia: 91.49 mm		
2.38	R C		
2.38	R IW		
6.33	DSF C		
<b>41158144</b>	Dia: 91.49 mm		
2.38	M C		
2.38	M		
4.75	DSF C		
<b>68501</b>	DIA:91.49 mm		
2.385	R CFP		
2.385	R IW P		
3.16	Lm		
6.335	Du		
6.335	S P		
<b>41158029</b>	Dia: 98.48 mm		
2.385	R CFP		
2.385	R IW P		
2.385	R IW P		
6.35	Du		
6.35	S P		
<b>41158041</b>	Dia: 98.48 mm		
2.385	R CFP		
2.385	R IW P		
2.385	R IW P		
6.335	DSF C		
6.335	S P		





		DETAIL		
41158045 Dia: 98.48 mm				
2.38	R	C		
2.38	R IW	C		
6.33	DSF	C		



		DETAIL		
4181A022 Dia: 98.48 mm				
3.16	T	Mo		
2.38	M	C		
4.75	DSF	C		



		DETAIL		
4181A019 Dia: 100.00 mm				
2.5	R IF	MoF		
2.5	M			
4.0	DSF	C		





		DETAIL		
4181A021 Dia: 100.00 mm				
2.9	T	MoF		
2.5	M			
4.0	DSF	C		





		DETAIL		
4181A026 Dia: 100.00 mm				
3.5	T	MoF		
2.5	M			
4.0	DSF	C		





		DETAIL		
4181A033 Dia: 100 mm				
3.50	T	MoF P		
2.50	NM			
3.50	DSF	C		





		DETAIL		
4181A041 Dia: 100 mm				
2.50	IF	C		
2.50	M			
4.00	DSF	C		

		DETAIL		
41158022 Dia: 101.05 mm				
2.50	R IW	MoF		
2.50	NM IW			
5.00	DSF	C		

		DETAIL		
4181A009 Dia: 101.05 mm				
2.385	M	C		
2.385	R IF	C		
2.385	R IF	C		
6.36	DSF	C		





		DETAIL		
4181A009 Dia: 101.05 mm				
2.385	M	C		
2.385	R IF	C		
2.385	NM			
6.36	DSF	C		





		DETAIL		
41158121 Dia: 107.95 mm				
3.17	R	C		
3.19	M			
3.19	M			
6.33	S			
6.33	S			





		DETAIL		
41158118 Dia: 114.31 mm				
2.38	R	C		
2.38	R IW			
2.38	R IW			
6.33	DSF	C		





## MASSEY FERGUSON / PERKINS ENGINES





RING TECHNICAL فنی رینگ

		DETAIL	
KRP1251 Dia: 130.17 mm			
3.17	T	Mo F	
3.22	R IF	C	
4.77	DSF	C	

		DETAIL	
4181A045 Dia: 103 mm			
2.5	R	MoF P	
2.5	NM	P	
3.5		C	

		DETAIL	
4181A046 Dia: 103.5 mm			
2.5	R	MoF P	
2.5	NM	P	
3.5	DSF	C	

		DETAIL	
URPK0002 Dia: 105 mm			
3.5	T	MoF P	
2.5	IFU	P	
3.5	DSF	C P	

		DETAIL	
URPK0003 Dia: 105 mm			
2.5	R	MoF P	
2.5	IFU	P	
3.5	DSF	C P	

Ring Coating Key		Ring Profile Key			
CF	Chrome Filled	R	Rectangular	G	Double Bevelled Oil Ring
C	Chrome Plated	T	Keystone	GSF	Double Bevelled Oil Ring with Coil Spring
MoF	Molybdenum Filled	M	Taper Face	Lm	Laminated steel segments
Mo	Molybdenum Coated	N	Napier	Du	Duaflex
Sn	Tin plated (Full)	NM	Taper Faced Napier	IF	Inside Bevel, top
Snp	Tin plated peripheral	S	Plain Slotted Oil Ring	IFU	Inside Bevel, bottom (reverse torsion)
P	Phosphated	SSF	Slotted Oil Ring with Coil Spring	IW	Inside Step, top
		D	Bevelled Edge Oil Ring	IWU	Inside Step, bottom (reverse torsion)
		DSF	Bevelled Edge Oil Ring with Coil Spring		





AT ATLASSIAN, WE PLACE UNWAVERING TRUST IN OUR ENGINEERS AND PRODUCTS. THAT'S WHY YOU CAN CONFIDENTLY PURCHASE ANY OF OUR PRODUCTS FROM ANYWHERE IN THE WORLD, WITH FULL WARRANTY COVERAGE, AND ENJOY PEACE OF MIND KNOWING YOU'RE GETTING EXCEPTIONAL QUALITY. OUR GOAL HAS ALWAYS BEEN TO DELIVER WORLD-CLASS PRODUCTS WITH SUPERIOR QUALITY AT COMPETITIVE PRICES. TO DATE, WE ARE PROUD OF OUR CONTINUED SUCCESS IN THIS MISSION, AND WE ARE DEDICATED TO CONTINUOUSLY EXCEEDING OUR CUSTOMERS' EXPECTATIONS

در اطلسیان، ما به مهندسی و محصولات خود اعتماد بی‌چون و چرا داریم. به همین دلیل است که شما می‌توانید با اطمینان کامل هر یک از محصولات ما را از هر کجای دنیا خریداری کنید، با پوشش گارانتی کامل، و از آرامش خاطر برخوردار باشید که کیفیت بی‌نظیری را دریافت می‌کنید. هدف ما همیشه ارائه محصولات کلاس جهانی با کیفیت برتر و قیمت‌های رقابتی بوده است. تا به امروز، ما به موفقیت مداوم خود در این مأموریت افتخار می‌کنیم و متعهد هستیم که به طور مداوم از انتظارات مشتریان خود فراتر برویم.

# INFINITE QUALITY



**ATLASSIAN**

